



## Self-contained ice maker - Paddle system Daily production up to 28 kg

Hotel	████████████████████
Restaurant	████████████████████
Fast food	████████████████████
Bar	████████████████████
Disco	████████████████████
Fish market	████████████████████
Supermarket	████████████████████
Medical & SPA	████████████████████
Industry	████████████████████

### ► Position n°



### ► Features & Plus

- Hollow cube
- AISI 304 SS Scotch Brite finish
- Tropical class +43°C
- Removable and cleanable air filter
- Air or water cooling system
- Easy cleanable internal rounded surfaces
- HCFC-Free insulated storage
- FDA approved -ABS water basin
- Basin tipping safety system
- RoHS Free
- Disappearing insulated door
- Electromechanical operation
- ON-OFF rocker switch
- Automatic water charge
- Standard and special voltages



AISI 304 SS Scotch Brite finish



Removable and cleanable air filter



FDA approved - ABS water basin



Disappearing insulated door

### ► Available ice cube size

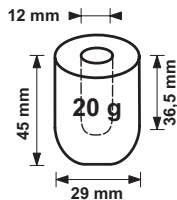

### ► Prod. 24h

Air temp.	Water temp.		kg	lbs
	10° C	50° F		
10° C	50° F	7° C	28	62
21° C	70° F	15° C	25	55

**2 Years Warranty**  
subject to limitations

### ► Certifications available for this model





Ice Finger

# IMF 28



## Self-contained ice maker - Paddle system Daily production up to 28 kg

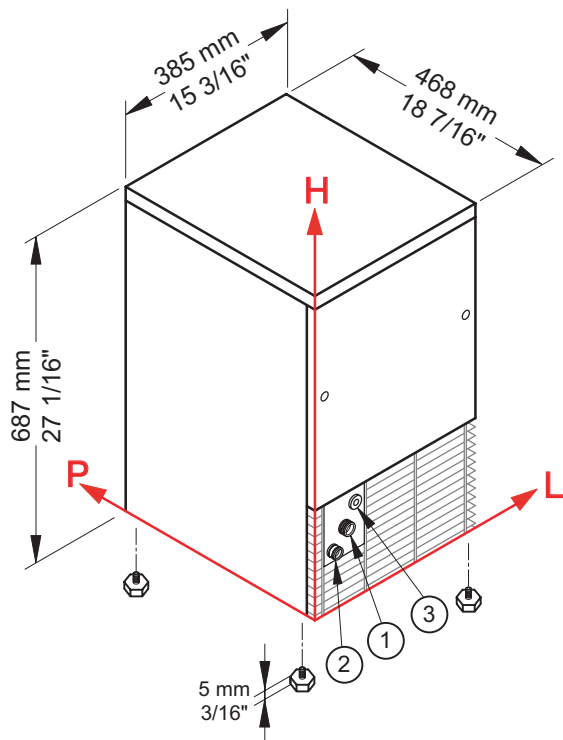

### ► Working conditions

- Location: **Indoor**

	Min	Max
Ambient temperature	+10° C / +50° F	+43° C / 110° F
Water temperature	+3° C / +37° F	+32° C / +90° F
Voltage	-10%	+10%
Water inlet pressure	1bar (14 psi)	6bar (84 psi)

### ► Performances

	Air temperature	Water temperature	Water temperature				
			7° C	45° F	15° C	60° F	21° C
	10° C	28 kg					
	50° F		62 lbs				
	21° C			25 kg			
	70° F				55 lbs		
	32° C					17 kg	
	90° F						37 lbs

### ► Connections

All measures are referred to the rear bottom-left corner (L-H-Ø)

- ① Water in.: 111 mm / 4 6/16" - 175 mm / 6 14/16" - 3/4"      ② Water out.: 49 mm / 1 15/16" - 130 mm / 5 2/16" - 24 mm / 15/16"  
 ③ Electrical connections: 156 mm / 6 2/16" - 211 mm / 8 5/16"

### ► Technical information

Production in 24h	25 kg / 55 lbs
Store capacity, up to	8 kg / 18 lbs
Cooling system	A - W
Kind of cube	A-20g
Refrigerant	R404A - R452A
Standard voltage	220-240 V ~ 50 Hz
Average power consumption	310 W
Fuse	10 A
Finish	AISI 304 stainless steel, scotch brite

Water consumption	A: 4,5 l/kg - 53,9 gal/100 lbs
	W: 15,5 l/kg - 185,7 gal/100 lbs
Sizes (L-P-H mm)	385 - 468 - 687
(L-P-H in)	15 3/16 - 18 7/16 - 27 1/16
Sizes with pack (L-P-H mm)	440 - 520 - 880
(L-P-H in)	17 5/16 - 20 8/16 - 34 10/16
Net weight	38 kg / 84 lbs
Gross weight	45 kg / 99 lbs

All the technical information must be considered at the following conditions:

- Sizes without feet
- Standard Cube (20 g)
- Ambient temperature +21° C
- Water temperature +15° C
- Average power consumption at +43° C (standard voltage)

Models and specifications are subject to change without notice

Rev. 04 - Issued September 2019



[www.bremaice.it](http://www.bremaice.it)  
[info@bremaice.it](mailto:info@bremaice.it)

Bim + Data  
download

