

## Frozen Frozen granita dispenser with 3 bowls, electronic control

ITEM # \_\_\_\_\_

MODEL # \_\_\_\_\_

NAME # \_\_\_\_\_

SIS # \_\_\_\_\_

AIA # \_\_\_\_\_

**560008 (IPRO3E)**

 Frozen Granita Dispenser  
 with 3X11 l insulated bowls,  
 electronic control

### Short Form Specification

Item No. \_\_\_\_\_

Frozen granita dispenser with 3 bowls; the ITANK™ Technology prevents ice accumulation on the outer side of the bowl and the bowl shape allows a natural mixing action to ensure an optimum consistency of the product. Customizable lid merchandiser and back graphic. Electronic control system and touch screen keypad. Sliding drip tray.

### Main Features

- Ideal for the production of slush.
- The ITANK™ Technology prevents ice accumulation on the outer side of the bowl, reducing condensation and increasing the cooling power of the machine.
- Bowl shape allows a natural mixing action to ensure an optimum consistency of the product.
- Customizable lid merchandiser and back graphic.
- Daily and weekly machine programming functionality.
- When the product reaches the right consistency, an automatic stand-by mode activates in order to save energy and reduce CO2 emissions.
- The insulated tank guarantees higher cooling efficiency and lower effect of the external temperature on product's preparation and maintenance time reducing condensing and draining; it is the best solution in hot climate conditions.
- Electronic control system and touch screen keypad.
- Sliding drip tray.

APPROVAL: \_\_\_\_\_

Front

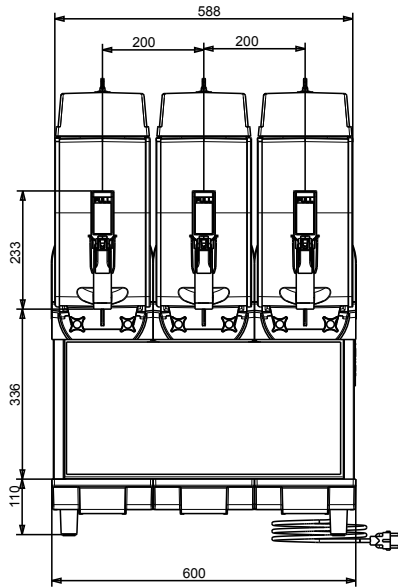

Side

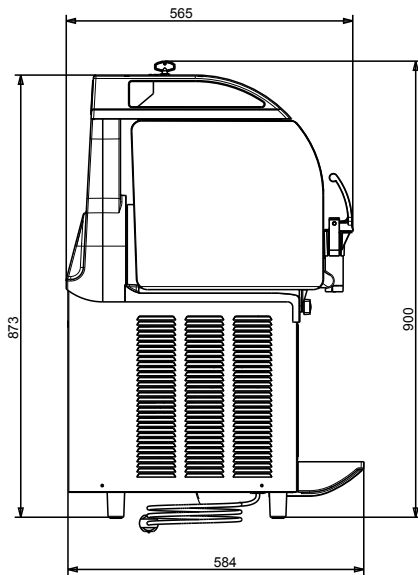

Top

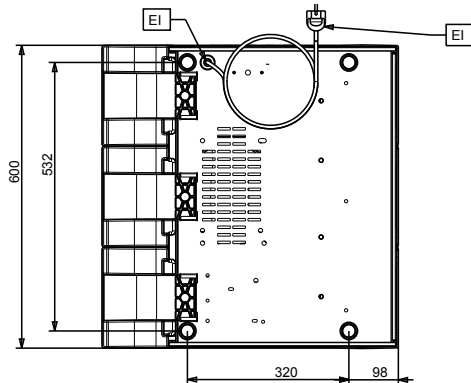

## Electric

### Supply voltage:

560008 (IPRO3E) 220-240 V/1 ph/50 Hz

### Electrical power max.:

1.4 kW

## Key Information:

External dimensions, Width: 600 mm

External dimensions, Height: 870 mm

External dimensions, Depth: 580 mm

Net weight: 81 kg

## Refrigeration Data

Refrigerant type: R452A